

# BESSER VERTICAL-HORIZONTAL SPLITTER

HVSPLITTER LOGIC:453242 ELEM:453243 REV - 5/26/93  
 Program Listing Processor File: HVSPLIT.ACH

May 26, 1993 Page 4  
 Rung 2:7

Rung 2:7  
 CONVEYOR IS RUNNING FORWARD / ADD ENCODER COUNTS TO POSITION

	ENCODER COUNTS UP		
	B3		+ADD-----+
----	]	[-----	+ADD-----+
	2		Source A N7:22
			0
			Source B N7:21
			0
			Dest N7:22
			0
			-----+

N7:21  
     -ADD- 2:7  
     -SUB- 2:6 2:8

N7:22  
     -ADD- 2:7 2:7  
     -GRT- 2:9  
     -LES- 2:9  
     -MOV- 2:5  
     -MUL- 2:9  
     -SUB- 2:8 2:8

Rung 2:8  
 CONVEYOR IS RUNNING REVERSE / SUBTRACT ENCODER COUNTS FROM POSITION

	ENCODER COUNTS UP		
	B3		+SUB-----+
----	)]	/[-----	+SUBTRACT-----+
	2		Source A N7:22
			0
			Source B N7:21
			0
			Dest N7:22
			0
			-----+

N7:21  
     -ADD- 2:7  
     -SUB- 2:6 2:8

N7:22  
     -ADD- 2:7 2:7  
     -GRT- 2:9  
     -LES- 2:9  
     -MOV- 2:5  
     -MUL- 2:9  
     -SUB- 2:8 2:8

# BESSER VERTICAL-HORIZONTAL SPLITTER

HVSPLITTER LOGIC:453242 ELEM:453243 REV - 5/26/93  
 Program Listing Processor File: HVSPLIT.ACH

May 26, 1993 Page 5  
 Rung 2:9

Rung 2:9

SCALES ENCODER COUNTS INTO EXACT PUSHER BAR LOCATION IN INCHES

+GRT-----+	+LES-----+	+MUL-----+
+GREATER THAN	+LESS THAN	+MULTIPLY
Source A      N7:22	Source A      N7:22	Source A      N7:22
0	0	0
Source B      -10000	Source B      10000	Source B           2
		Dest           N7:23
		0
		+SUB-----+
		+SUBTRACT
		Source A      N7:24
		4000
		Source B      N7:23
		0
		Dest           N7:0
		4000

N7:0

```
-ADD- 2:52
-GRT- 2:53
-SUB- 2:9 2:10
```

N7:22

```
-ADD- 2:7 2:7
-GRT- 2:9
-LES- 2:9
-MOV- 2:5
-MUL- 2:9
-SUB- 2:8 2:8
```

N7:23

```
-MUL- 2:9
-SUB- 2:9
```

N7:24

```
-SUB- 2:9
```

Rung 2:10

STOP PUSHER BAR EARLY DISTANCE TO OFFSET PUSHER BAR OVERTRAVEL AFTER STOP  
 COMMAND

+SUB-----+
+SUBTRACT
Source A      N7:0
4000
Source B      N7:12
10
Dest           N7:25
3990

N7:0

```
-ADD- 2:52
-GRT- 2:53
-SUB- 2:9 2:10
```

**BESSER VERTICAL-HORIZONTAL SPLITTER**

---

HVSPLITTER LOGIC:453242 ELEM:453243 REV - 5/26/93  
 Program Listing Processor File: HVSPLIT.ACH

May 26, 1993 Page 6  
 Rung 2:11

N7:12  
         -SUB- 2:10

N7:25  
         -LEQ- 2:35 2:37 2:39 2:41 2:43 2:45  
         -SUB- 2:10 2:11

Rung 2:11  
 DECEL PUSHER DISTANCE BEFORE SPLIT LOCATION

+SUB-----+	
SUBTRACT	
Source A	N7:25
	3990
Source B	N7:13
	0
Dest	N7:27
	3990
+-----+	

N7:13  
         -SUB- 2:11

N7:25  
         -LEQ- 2:35 2:37 2:39 2:41 2:43 2:45  
         -SUB- 2:10 2:11

N7:27  
         -LEQ- 2:21 2:23 2:25 2:27 2:29 2:31  
         -SUB- 2:11

Rung 2:12  
 TIME DELAY BEFORE ACCEPTING FORWARD PRESSURE SWITCH ON

KNIFES	LS-5
EXTEND	PRESSURE
	SWITCH
O:0.0	I:0.0
-----] [-----]	-----] [-----]
3	5

+TON-----+	
TIMER ON DELAY	
Timer	T4:1
Time Base	0.01
Preset	20
Accum	0
+-----+	

T4:1  
         -TON- 2:12

# BESSER VERTICAL-HORIZONTAL SPLITTER

HVSPLITTER LOGIC:453242 ELEM:453243 REV - 5/26/93  
 Program Listing Processor File: HVSPLIT.ACH

May 26, 1993 Page 7  
 Rung 2:13

Rung 2:13  
 TIME DELAY BEFORE ACCEPTING FORWARD PRESSURE SWITCH OFF

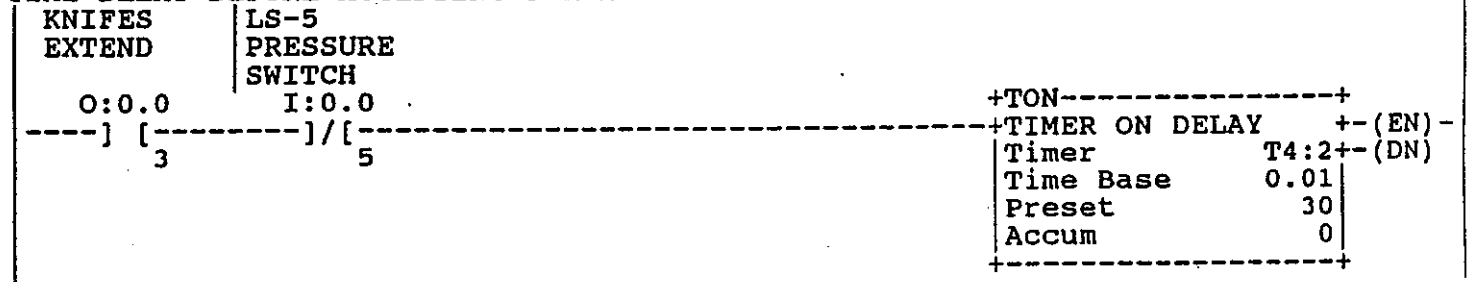

T4:2  
 -TON- 2:13

Rung 2:14  
 TIME DELAY BEFORE ACCEPTING REVERSE PRESSURE SWITCH ON

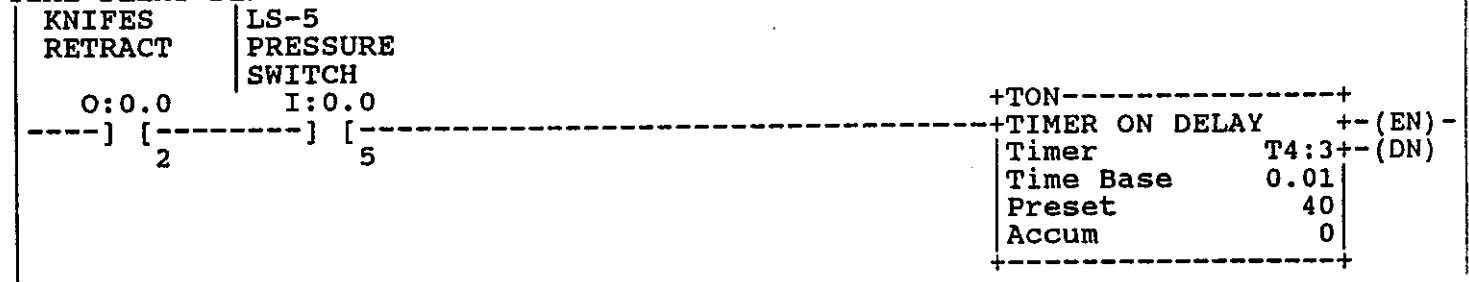

T4:3  
 -TON- 2:14

Rung 2:15  
 TIME DELAY BEFORE SHUTTING SPLITTER DOWN BECAUSE OUTBOARD CONVEYOR FULL

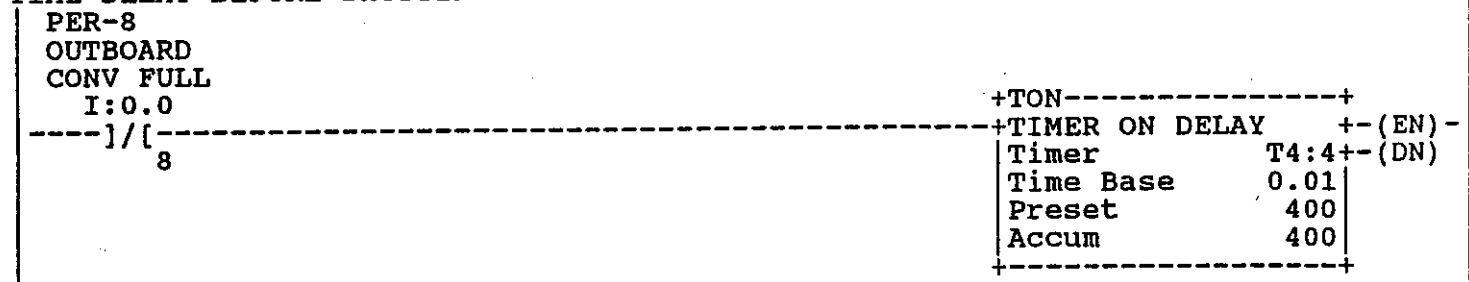

T4:4  
 -TON- 2:15

# BESSER VERTICAL-HORIZONTAL SPLITTER

HVSPLITTER LOGIC:453242 ELEM:453243 REV - 5/26/93  
 Program Listing Processor File: HVSPLIT.ACH

May 26, 1993 Page 8  
 Rung 2:16

**Rung 2:16**

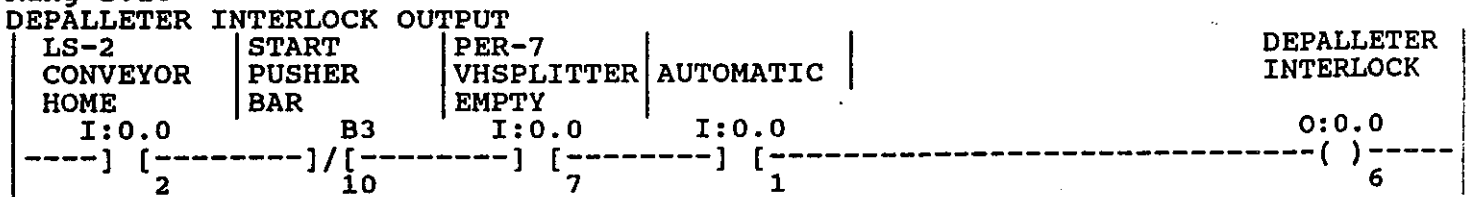

O:0.0/6  
 -( )- 2:16

**Rung 2:17**

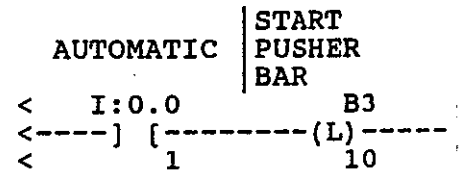
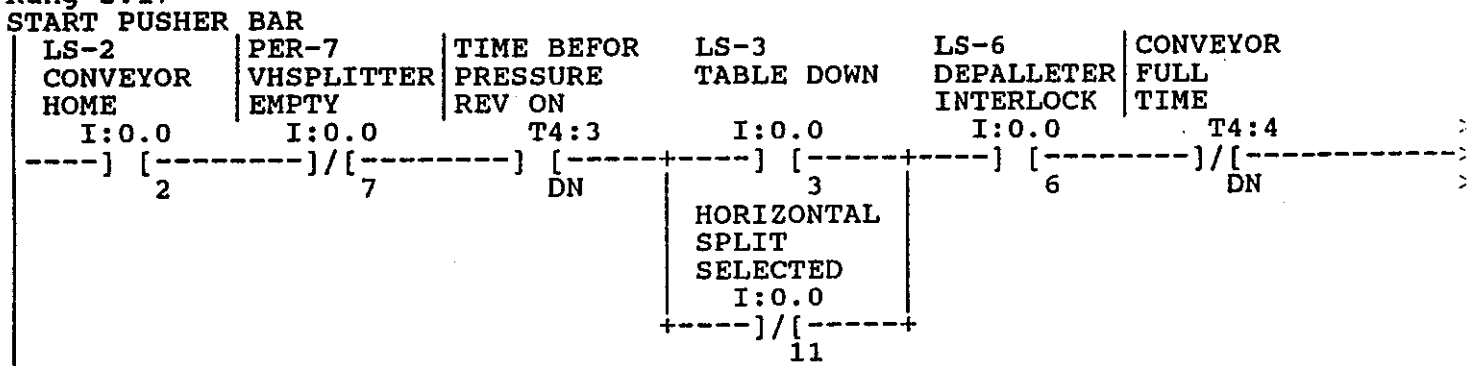

B3/10

-] [- 2:20  
 -]/[- 2:16  
 -(L)- 2:17  
 -(U)- 2:18

# BESSER VERTICAL-HORIZONTAL SPLITTER

HVSPLITTER LOGIC:453242 ELEM:453243 REV - 5/26/93  
 Program Listing Processor File: HVSPLIT.ACH

May 26, 1993 Page 9  
 Rung 2:18

**Rung 2:18**

**START PUSHER BAR**

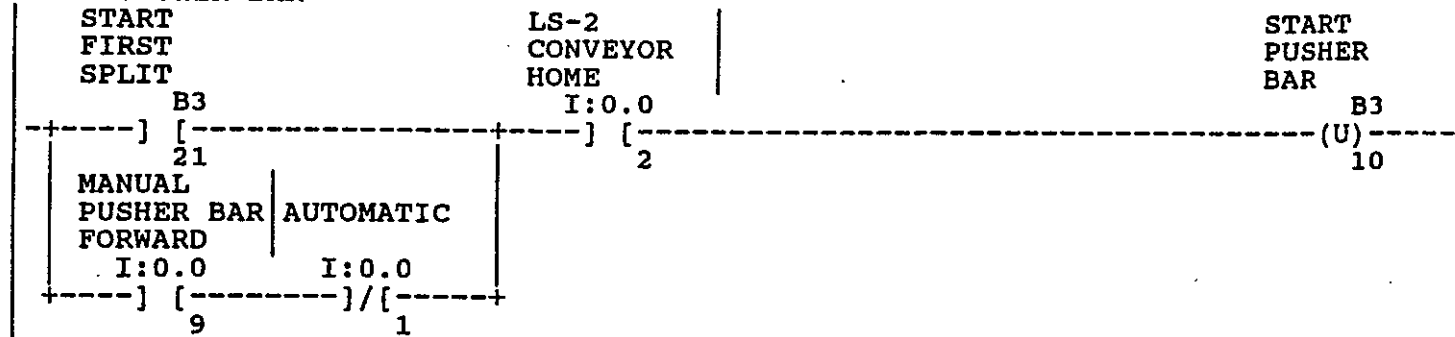

B3/10

```

-] [- 2:20
-]/[- 2:16
-(L)- 2:17
-(U)- 2:18
  
```

**Rung 2:19**

**TIME PUSHER BAR STOPS AT HOME IN MANUAL**

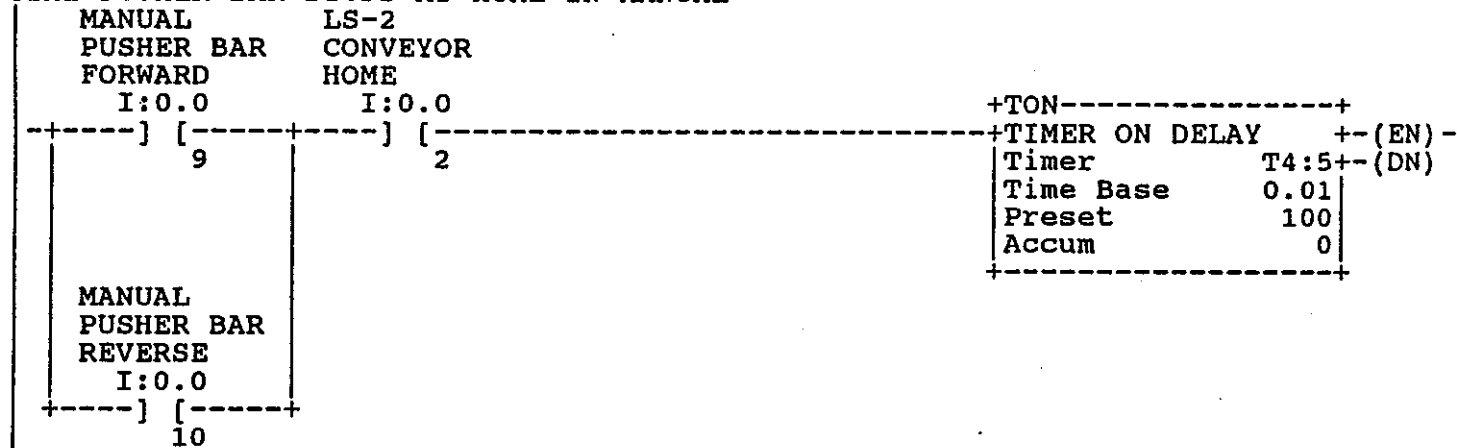

T4:5

-TON- 2:19

**Rung 2:20**

**PUSHER BAR FORWARD OUTPUT**

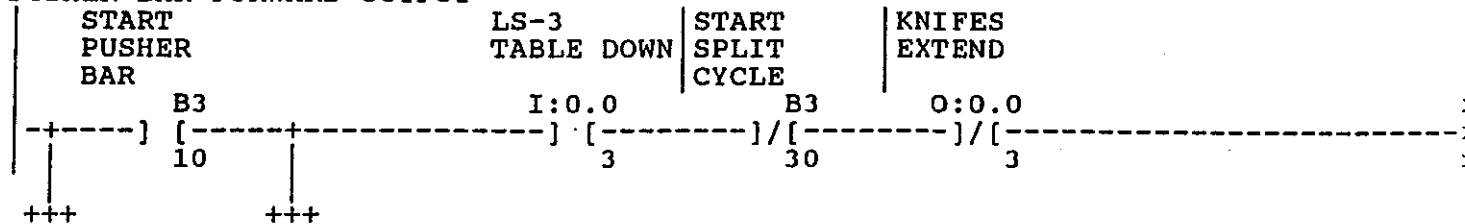

# BESSER VERTICAL-HORIZONTAL SPLITTER

HVSPLITTER LOGIC:453242 ELEM:453243 REV - 5/26/93  
 Program Listing Processor File: HVSPLIT.ACH

May 26, 1993 Page 10  
 Rung 2:20

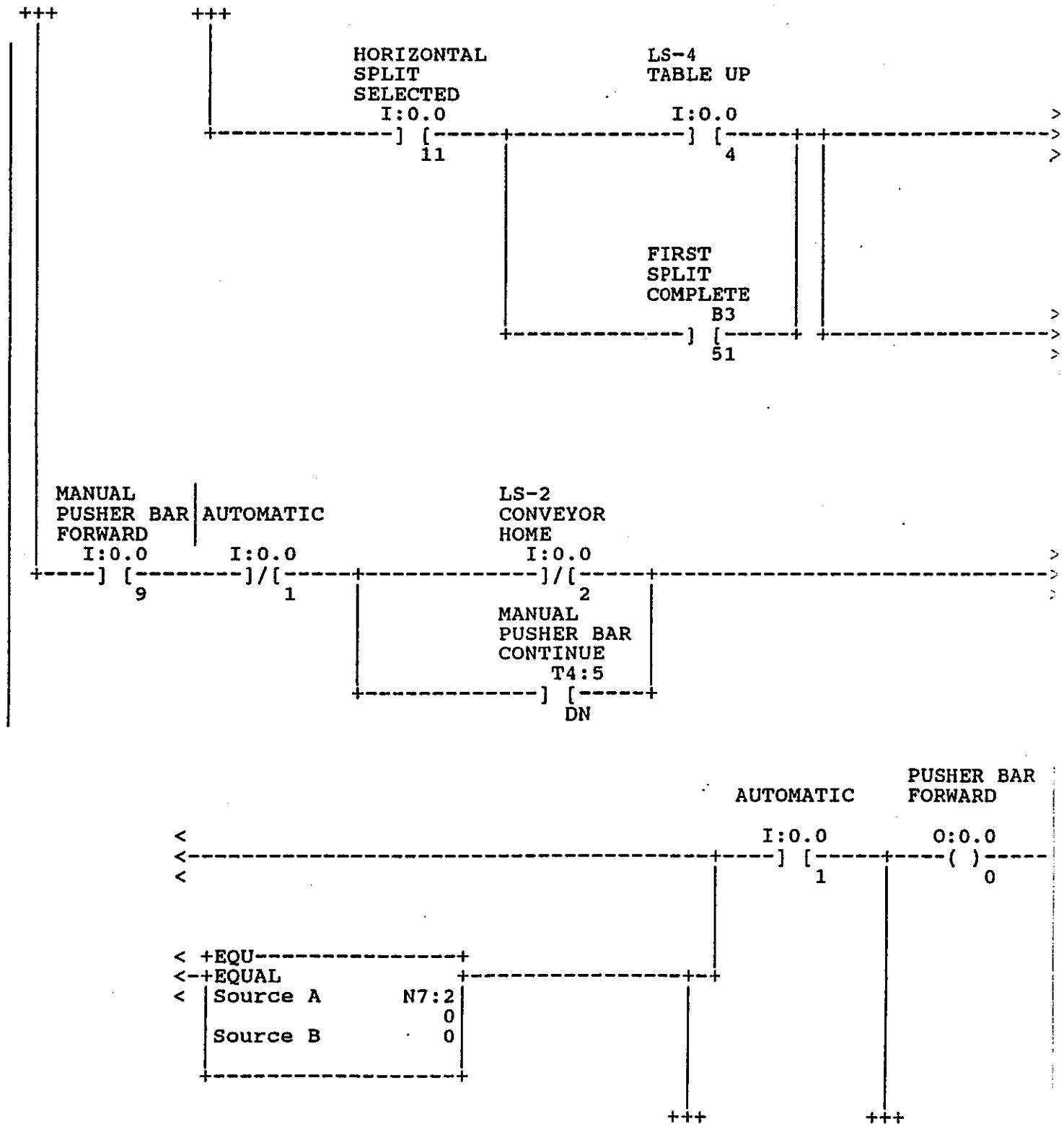

# BESSER VERTICAL-HORIZONTAL SPLITTER

HVSPLITTER LOGIC:453242 ELEM:453243 REV - 5/26/93  
 Program Listing Processor File: HVSPLIT.ACH

May 26, 1993 Page 11  
 Rung 2:20

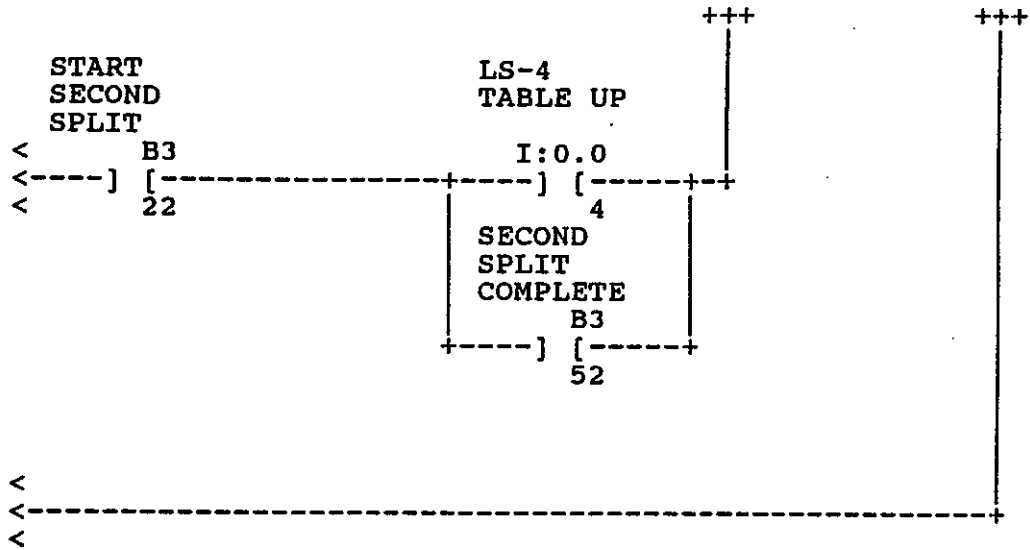

0:0.0/0

```

-] [- 2:0 2:2 2:34
-]/[- 2:54
-( )- 2:20
    
```

Rung 2:21  
 DECEL PUSHER BAR FOR FIRST SPLIT

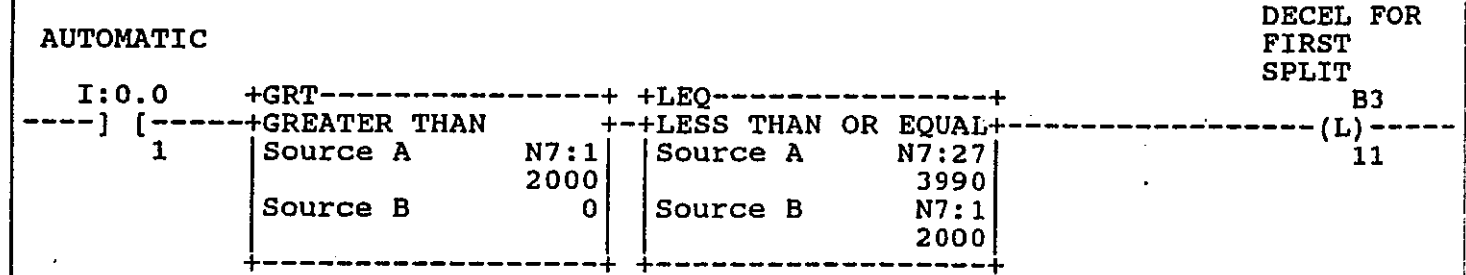

B3/11

```

-] [- 2:33
-(L)- 2:21
-(U)- 2:22
    
```



# BESSER VERTICAL-HORIZONTAL SPLITTER

HVSPLITTER LOGIC:453242 ELEM:453243 REV - 5/26/93  
 Program Listing Processor File: HVSPLIT.ACH

May 26, 1993 Page 13  
 Rung 2:25

Rung 2:25  
 DECEL PUSHER BAR FOR THIRD SPLIT

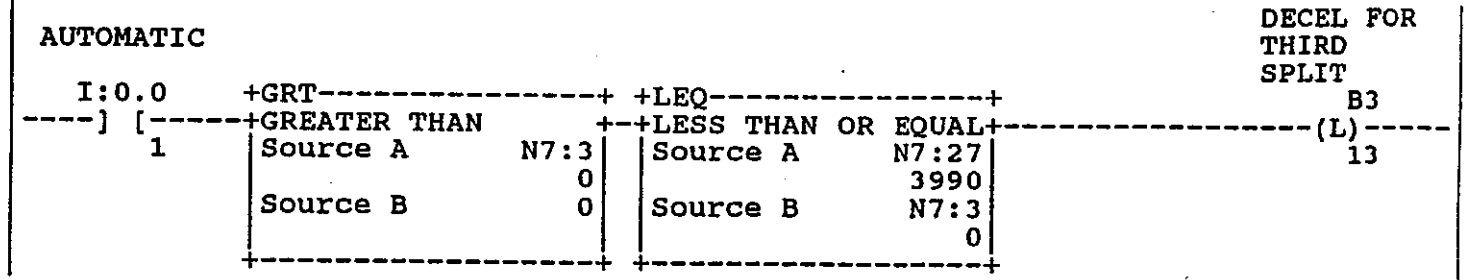

B3/13

-] [- 2:33  
 -(L)- 2:25  
 -(U)- 2:26

Rung 2:26  
 DECEL PUSHER BAR FOR THIRD SPLIT



B3/13

-] [- 2:33  
 -(L)- 2:25  
 -(U)- 2:26

Rung 2:27  
 DECEL PUSHER BAR FOR FOURTH SPLIT

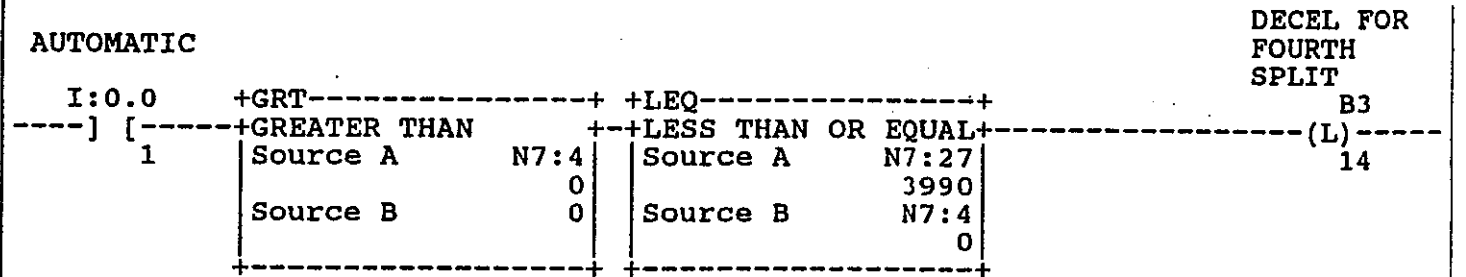

B3/14

-] [- 2:33  
 -(L)- 2:27  
 -(U)- 2:28

# BESSER VERTICAL-HORIZONTAL SPLITTER

HVSPLITTER LOGIC:453242 ELEM:453243 REV - 5/26/93  
 Program Listing Processor File: HVSPLIT.ACH

May 26, 1993 Page 14  
 Rung 2:28

Rung 2:28

DECEL PUSHER BAR FOURTH SPLIT

LS-2		DECEL FOR
CONVEYOR		FOURTH
HOME		SPLIT
I:0.0		B3
-----] [-----		(U)-----
2		14

B3/14

-] [- 2:33  
 -(L)- 2:27  
 -(U)- 2:28

Rung 2:29

DECEL PUSHER BAR FOR FIFTH SPLIT

AUTOMATIC		DECEL FOR
I:0.0		FIFTH
-----] [-----		SPLIT
1		B3
	+GRT-----+ +LEQ-----+	(L)-----
	GREATER THAN	15
	Source A N7:5	
	0	
	Source B 0	
	0	
	Source A N7:27	
	3990	
	Source B N7:5	
	0	

B3/15

-] [- 2:33  
 -(L)- 2:29  
 -(U)- 2:30

Rung 2:30

DECEL PUSHER BAR FOR FIFTH SPLIT

KNIFES		DECEL FOR
RETRACT		FIFTH
O:0.0		SPLIT
-----] [-----		B3
2		(U)-----
		15

B3/15

-] [- 2:33  
 -(L)- 2:29  
 -(U)- 2:30

# BESSER VERTICAL-HORIZONTAL SPLITTER

HVSPLITTER LOGIC:453242 ELEM:453243 REV - 5/26/93  
 Program Listing Processor File: HVSPLIT.ACH

May 26, 1993 Page 15  
 Rung 2:31

Rung 2:31  
 DECEL PUSHER BAR FOR SIXTH SPLIT

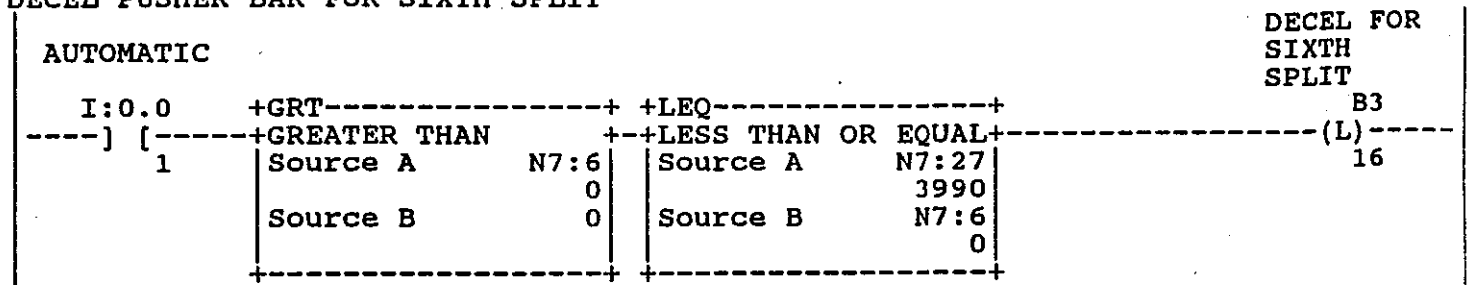

B3/16  
 -] [- 2:33  
 -(L)- 2:31  
 -(U)- 2:32

Rung 2:32  
 DECEL PUSHER BAR FOR SIXTH SPLIT

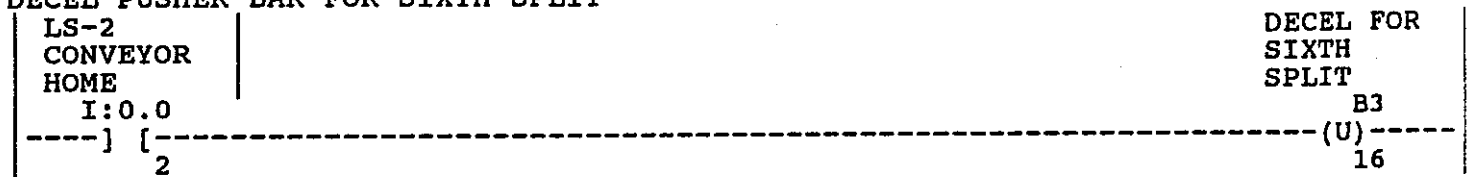

B3/16  
 -] [- 2:33  
 -(L)- 2:31  
 -(U)- 2:32

Rung 2:33  
 DECEL PUSHER BAR

